

CNZ1414A (ON1414A)

Integrated Photosensor

Overview

CNZ1414A is ultraminiature, highly reliable transmissive photosensor that has a high efficiency GaAs infrared light emitting diode chip and a low voltage operation type high sensitivity Si-integrated-photodetector chip which are in a double molded resin package.

Features

- Ultraminiature : 4.2 × 4.2 mm (height : 5.2 mm)
- Low voltage operation, low current consumption (V_{CC} = 2.2 to 7 V, I_{CC} = 0.8 mA typ.)
- Fast response : t_{PHL} = 3 μs, t_{PLH} = 8 μs (typ.)
- Highly precise position detection (slit width : 0.3 mm)
- Gap width : 1.2 mm
- With attachment positioning pin

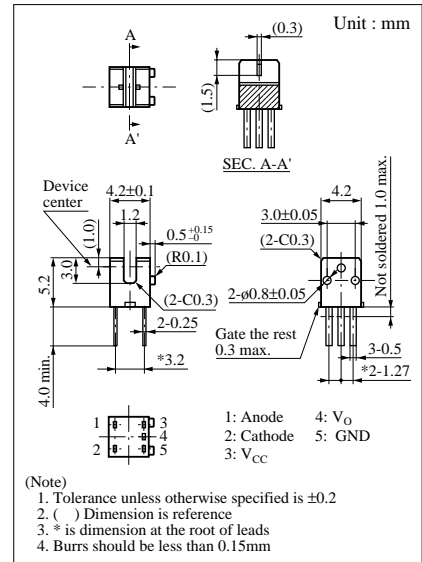

Absolute Maximum Ratings (Ta = 25°C)

	Parameter	Symbol	Ratings	Unit
Input (Light emitting diode)	Reverse voltage (DC)	V _R	6	V
	Forward current (DC)	I _F	50	mA
	Power dissipation	P _D ^{*1}	75	mW
Output (Photo IC)	Output current	I _O	8	mA
	Output voltage	V _O	12	V
	Supply voltage	V _{CC}	7	V
	Power dissipation	P _C ^{*2}	80	mW
Temperature	Operating ambient temperature	T _{opr}	-25 to +85	°C
	Storage temperature	T _{stg}	-40 to +100	°C

^{*1} Input power derating ratio is 1.0 mW/°C at Ta ≥ 25°C.

^{*2} Output power derating ratio is 1.07 mW/°C at Ta ≥ 25°C.

Pin Connection

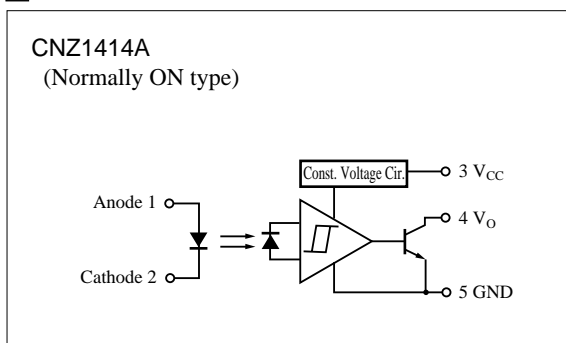

Note) The part number in the parenthesis shows conventional part number.

■ Electrical Characteristics (Ta = 25°C)

Parameter		Symbol	Conditions	min	typ	max	Unit
Input characteristics	Forward voltage (DC)	V_F	$I_F = 20\text{mA}$		1.2	1.4	V
	Reverse current (DC)	I_R	$V_R = 3\text{V}$			10	μA
Output characteristics	“H” Output current	I_{OH}	$V_{CC} = 5\text{V}, V_{OH} = 12\text{V}, I_F = 0\text{mA}$			100	μA
	“L” Output voltage	V_{OL}	$V_{CC} = 5\text{V}, I_{OL} = 5\text{mA}, I_F = 2\text{mA}$		0.15	0.4	V
	Operating power voltage	V_{CC}		2.2		7	V
	“L” Supply current	I_{CCL}	$V_{CC} = 5\text{V}, I_F = 2\text{mA}$		0.8	2	mA
	“H” Supply current	I_{CCH}	$V_{CC} = 5\text{V}, I_F = 0\text{mA}$		0.8	2	mA
Transfer characteristics	Threshold input current	$I_{FH \rightarrow L}$	$V_{CC} = 2.2\text{V}$			2	mA
	Hysteresis	I_{FLH}/I_{FHL}	$V_{CC} = 2.2\text{V}$		0.85		
	Response time	t_{PHL}^*	$V_{CC} = 5\text{V}, I_F = 2\text{mA}, R_L = 1\text{k}\Omega$			3	μs
t_{PLH}^*					8	μs	

* Switching time measurement circuit

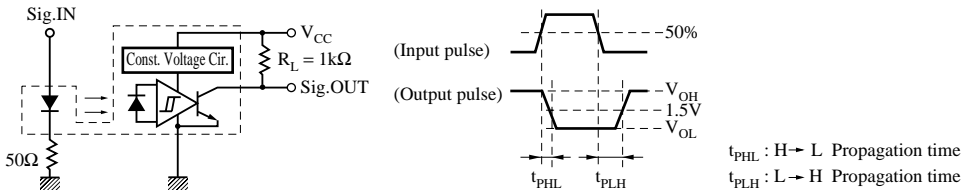

● Important Information for Soldering

1. Soldering Position

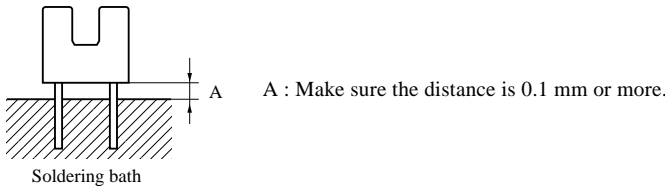

2. Solder Temperature and Soldering Time

- Temperature : 260°C or less
- Time : within 3 seconds
- Note) Avoid using reflow soldering methods.

3. Other Issues

- 1) Soldering should not create excessive thermal or mechanical stress on the case package or leads. Excessive stress may cause changes in the shape or characteristics of the package or leads.
- 2) Be careful not to allow solder, flux, solvents, etc. to remain on the case package. Doing so may cause problems related to transmission characteristics, etc.

● Important Information Related to Power Source Voltage

In order to stabilize the power line, use a decoupling capacitor of approximately 0.1 μF between V_{CC} and the GND line near the device .

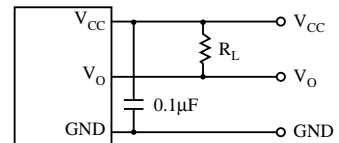

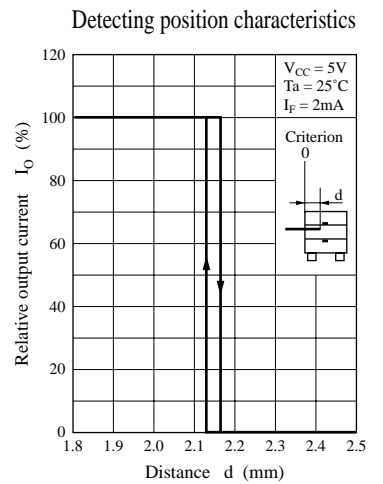
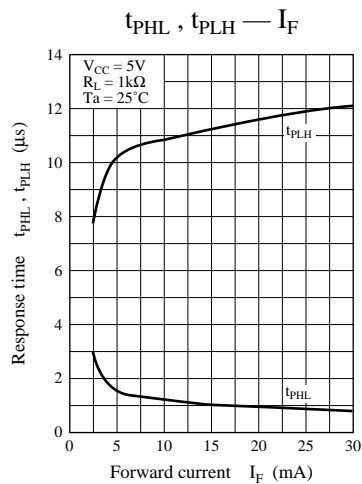
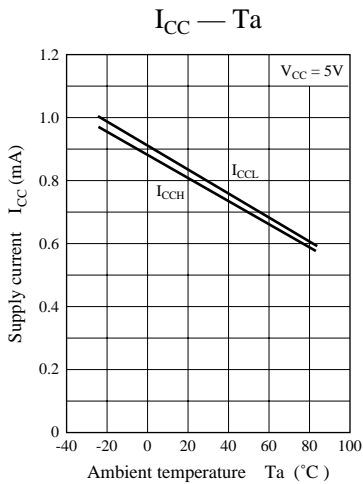
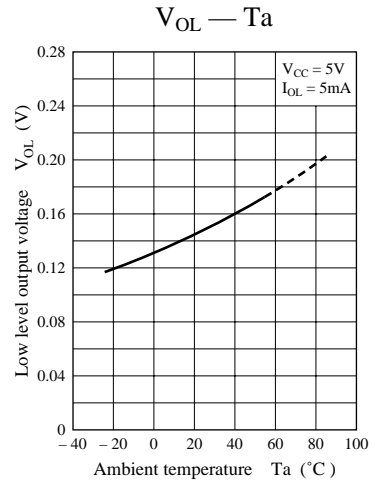
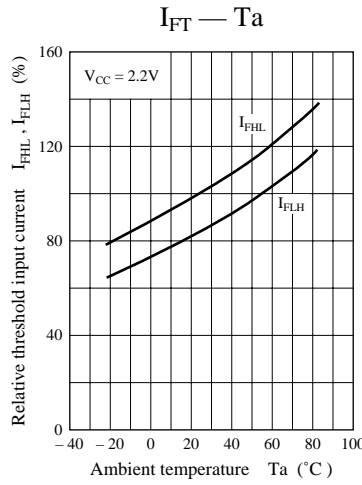
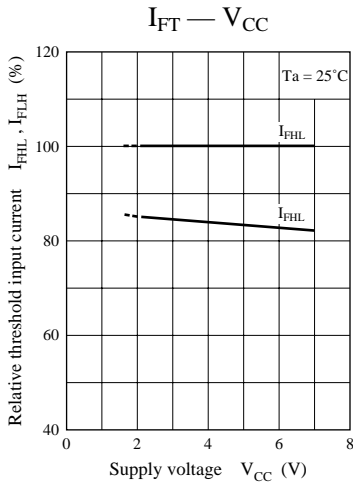
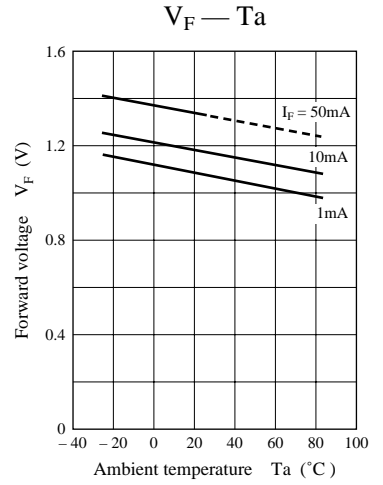
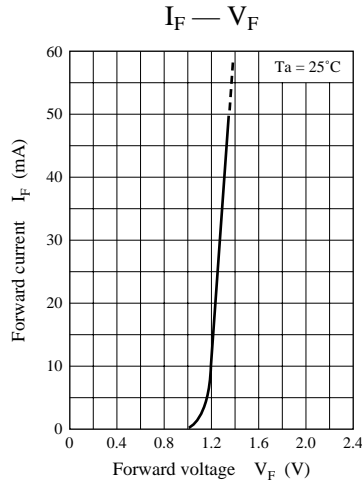
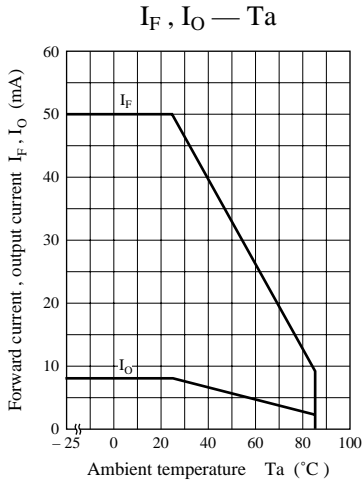

Caution for Safety

 **DANGER**

Gallium arsenide material (GaAs) is used in this product.

Therefore, do not burn, destroy, cut, crush, or chemically decompose the product, since gallium arsenide material in powder or vapor form is harmful to human health.

Observe the relevant laws and regulations when disposing of the products. Do not mix them with ordinary industrial waste or household refuse when disposing of GaAs-containing products.

Request for your special attention and precautions in using the technical information and semiconductors described in this material

- (1) An export permit needs to be obtained from the competent authorities of the Japanese Government if any of the products or technologies described in this material and controlled under the "Foreign Exchange and Foreign Trade Law" is to be exported or taken out of Japan.
- (2) The technical information described in this material is limited to showing representative characteristics and applied circuit examples of the products. It does not constitute the warranting of industrial property, the granting of relative rights, or the granting of any license.
- (3) The products described in this material are intended to be used for standard applications or general electronic equipment (such as office equipment, communications equipment, measuring instruments and household appliances).
Consult our sales staff in advance for information on the following applications:
 - Special applications (such as for airplanes, aerospace, automobiles, traffic control equipment, combustion equipment, life support systems and safety devices) in which exceptional quality and reliability are required, or if the failure or malfunction of the products may directly jeopardize life or harm the human body.
 - Any applications other than the standard applications intended.
- (4) The products and product specifications described in this material are subject to change without notice for reasons of modification and/or improvement. At the final stage of your design, purchasing, or use of the products, therefore, ask for the most up-to-date Product Standards in advance to make sure that the latest specifications satisfy your requirements.
- (5) When designing your equipment, comply with the guaranteed values, in particular those of maximum rating, the range of operating power supply voltage and heat radiation characteristics. Otherwise, we will not be liable for any defect which may arise later in your equipment.
Even when the products are used within the guaranteed values, redundant design is recommended, so that such equipment may not violate relevant laws or regulations because of the function of our products.
- (6) When using products for which dry packing is required, observe the conditions (including shelf life and after-unpacking standby time) agreed upon when specification sheets are individually exchanged.
- (7) No part of this material may be reprinted or reproduced by any means without written permission from our company.

Please read the following notes before using the datasheets

- A. These materials are intended as a reference to assist customers with the selection of Panasonic semiconductor products best suited to their applications.
Due to modification or other reasons, any information contained in this material, such as available product types, technical data, and so on, is subject to change without notice.
Customers are advised to contact our semiconductor sales office and obtain the latest information before starting precise technical research and/or purchasing activities.
- B. Panasonic is endeavoring to continually improve the quality and reliability of these materials but there is always the possibility that further rectifications will be required in the future. Therefore, Panasonic will not assume any liability for any damages arising from any errors etc. that may appear in this material.
- C. These materials are solely intended for a customer's individual use.
Therefore, without the prior written approval of Panasonic, any other use such as reproducing, selling, or distributing this material to a third party, via the Internet or in any other way, is prohibited.